

Central Article Code: G31080A09-B
 Local Code: EM960

Created: 17/07/2019
 Modified: 26/02/2020

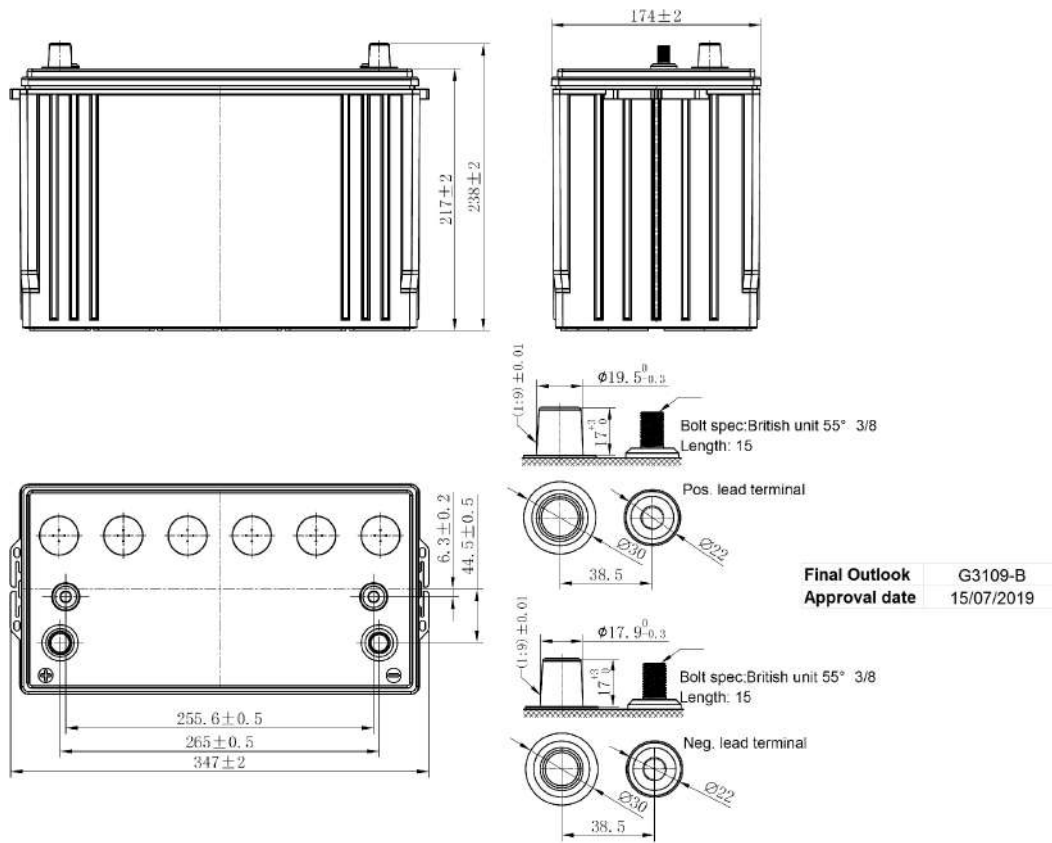

PERFORMANCES

Voltage (V):	12 V
C20 (Ah):	100.0 20 h
Cranking (A):	850 EN
Charge:	CHARGED
Technology:	AGM
Grid:	Ca/Ca
Vibration:	V3 (30Hz+/-2Hz/6g/20h)
Endurance:	E3 (144 cycles@50%)

STD. DIMENSIONS

Length (mm ± 2):	330
Width (mm ± 2):	173
Height (mm ± 2):	240
Total Weight (kg ± 5%):	31.20

All figures show nominal values. Tolerances are according to EN50342 and applicable European Regulations.

CONTAINER

Type:	G31	BLACK
Hold Down:	B0	
H.D. Adapter:	No	

COVER

Type:	Flat/Press	BLACK
Polarity:	ETN 1	
Terminals:	SAE M 3/8" taper&stud	
Terminal Adapter:	No	
SOCI:	No	
Ventilation:	Independent	
Filter:	No	
Lateral Plug:	No	

PLUGS

Type:	6 x M18 Valve	BLACK
-------	---------------	-------

HANDLES

Type:	None
-------	------

OTHERS

Degassing Tube:	No
3/8-3/8 nuts in plastic bag	